

構成内容 / Components				
No.	名称 / Part name	数量 / Pcs	材質 / Material	色・表面処理 / Color・Finish
1	上下カバー Top and Bottom cover	各1 1 each	アルミ板 A1100P t2.0 Aluminium A1100P t2.0	シルバーアルマイト Silver・Anodized
2	Wパネル W panel	2	アルミ板 A1100P t2.0 Aluminium A1100P t2.0	シルバーアルマイト Silver・Anodized
3	Dパネル D panel	2	アルミ板 A1100P t2.0 Aluminium A1100P t2.0	シルバーアルマイト Silver・Anodized
4	支柱 Extruded pillar	4	アルミ押出材 A6063S-T5 Extruded aluminium A6063S-T5	シルバーアルマイト Silver・Anodized
5	取付ビス (六角穴付皿M4 x 12) Screw (Hexagonal M4 - 12)	8	ステンレス Stainless steel	無処理 Unfinished
6	コーナーガード Corner guard	8	TPE	ブラック、グレー Black, Gray

■六角レンチ付です。  
Hexagonal wrench included.

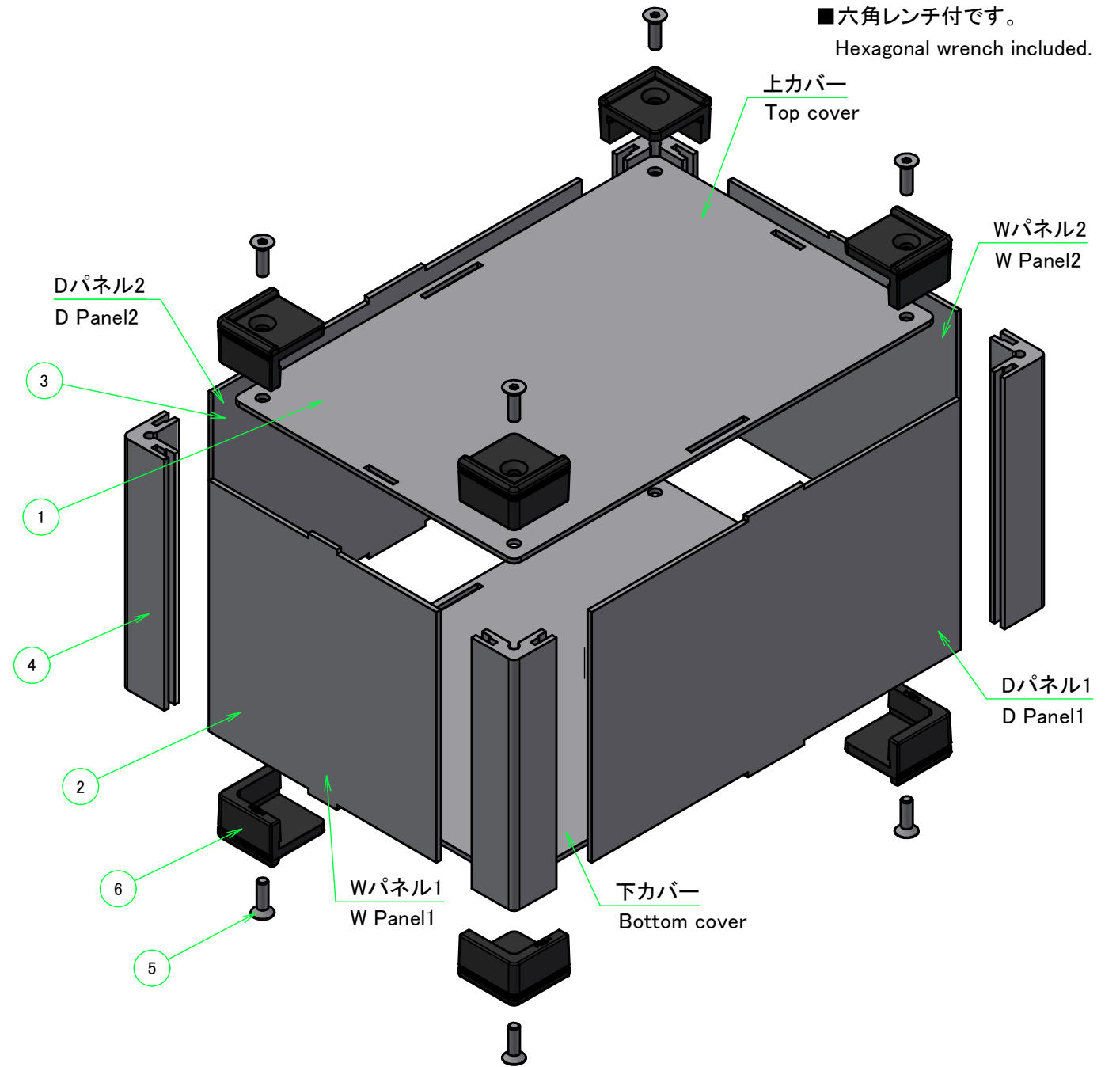

ケース型番 / Product Number

ALGF  -  -  **K20** -   
 W H D タイプ Type 色記号 Color code

W・H・D 寸法制限範囲 / Dimension limit range		
W	H	D
401 ~ 500	30 ~ 500	101 ~ 150

色仕様(型番末尾□) / Color Type(End of product number □)	
記号 / Code	コーナーガード / Corner guard
B	ブラック / Black
G	グレー / Gray

<b>TAKACHI</b> 株式会社タカチ電機工業 TAKACHI ELECTRONICS ENCLOSURE CO., LTD.			品名/Title コーナーガード付アルミフリーサイズケース CUSTOM SIZED ALUMINIUM FRAME BOX with CORNER GUARD	尺度/Scale
承認/Approved	検図/Checked	製図/Created	型番/Product number ALGF□-□-□K20□ (W401~500, D101~150)	
中根	中根	常山	作成日/Date 2022/06/24	1 / 6

外視 / External View

Wパネル2 / W Panel 2

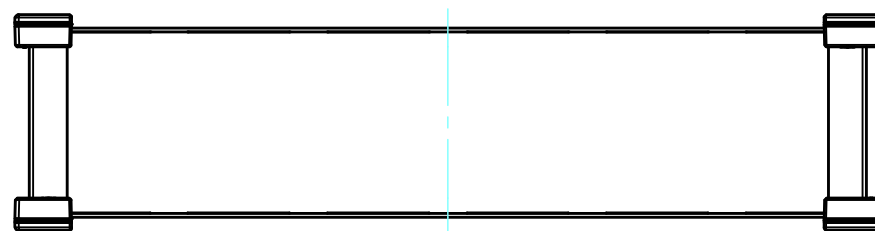

Dパネル2 / D Panel 2

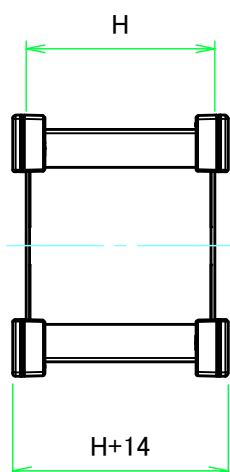

上カバー / Top cover

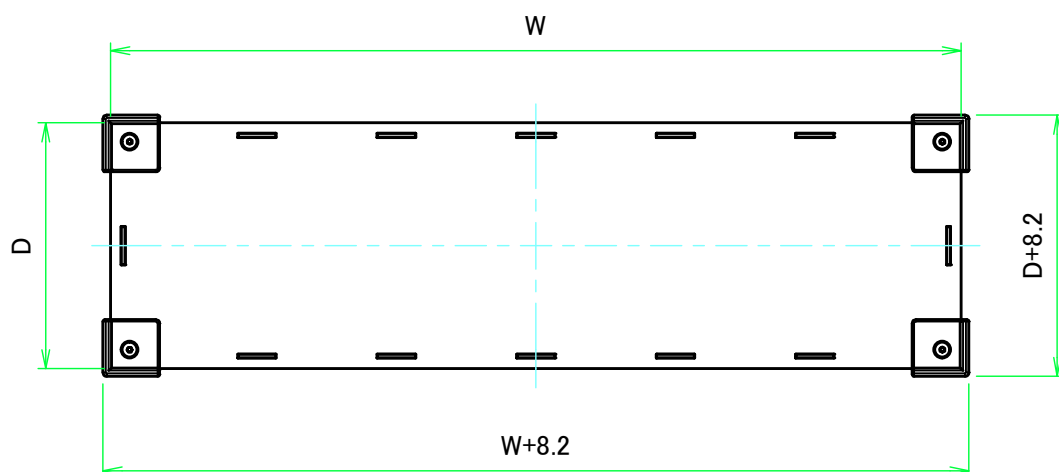

Dパネル1 / D Panel 1

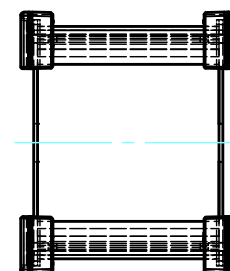

下カバー / Bottom cover

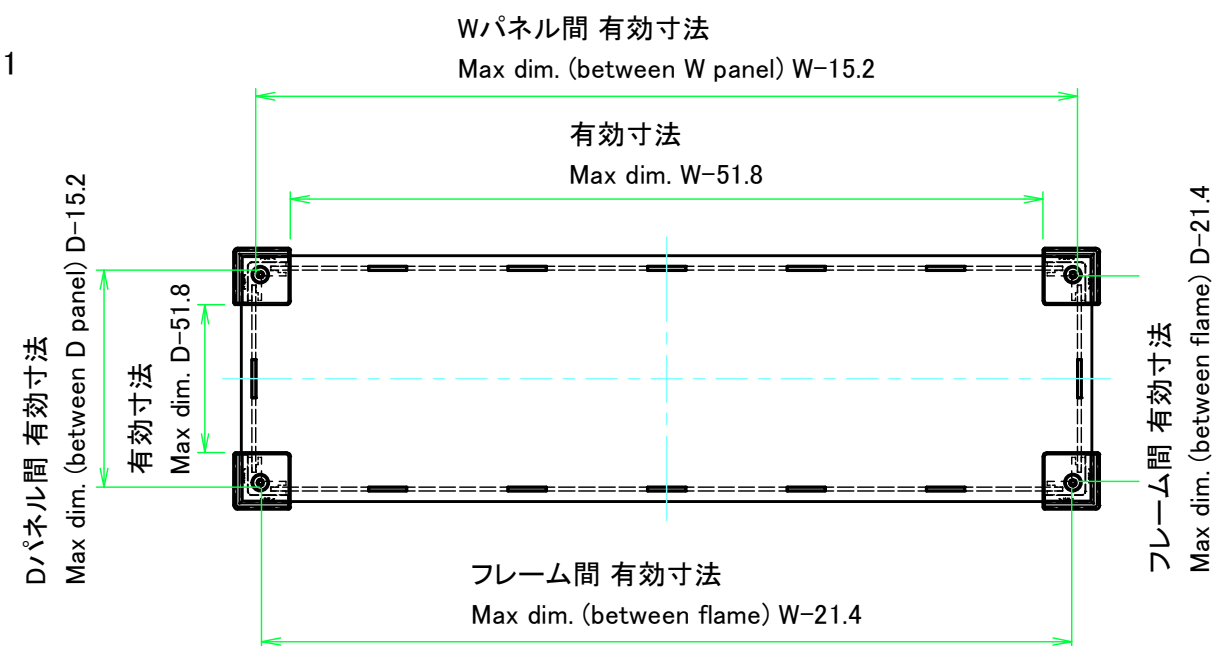

Wパネル1 / W Panel 1

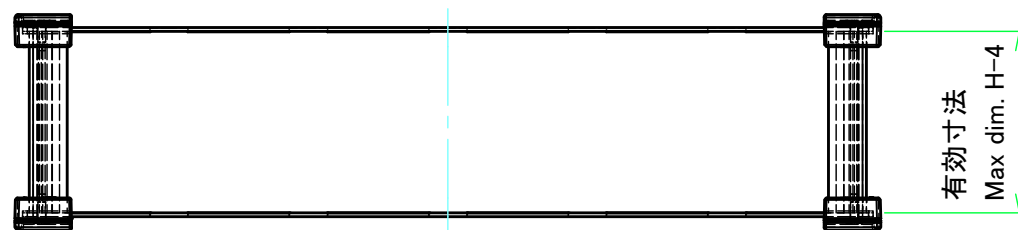

株式会社タカチ電機工業 TAKACHI ELECTRONICS ENCLOSURE CO., LTD.			品名/Title コーナーガード付アルミフリーサイズケース CUSTOM SIZED ALUMINIUM FRAME BOX with CORNER GUARD	尺度/Scale 1:4
承認/Approved	検図/Checked	製図/Created	型番/Product number ALGF□-□-□K20□ (W401~500, D101~150)	
中根	中根	常山	作成日/Date 2022/06/24	2 / 6

上下カバー / Top and Bottom cover

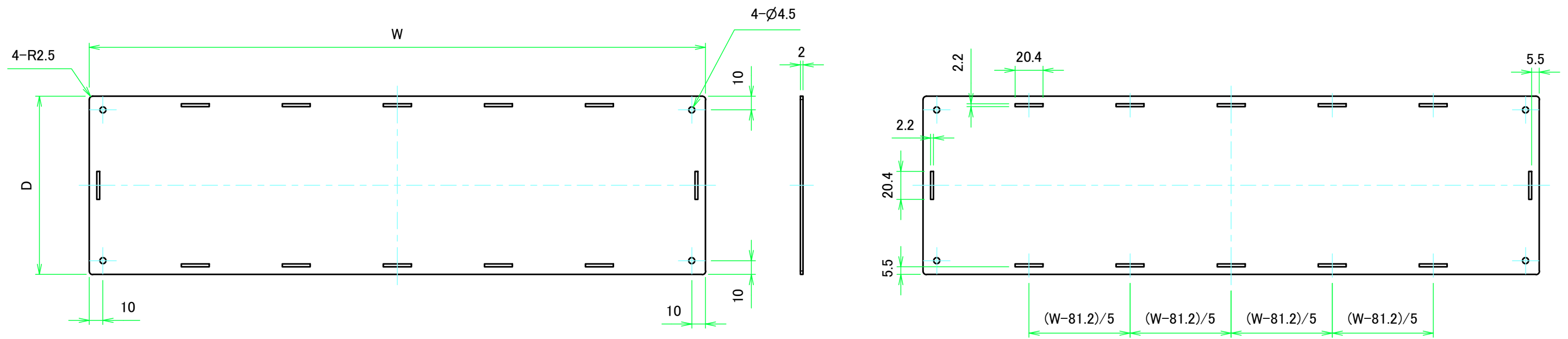

上カバー表面 / Top cover Frontside

上カバー裏面 / Top cover Backside

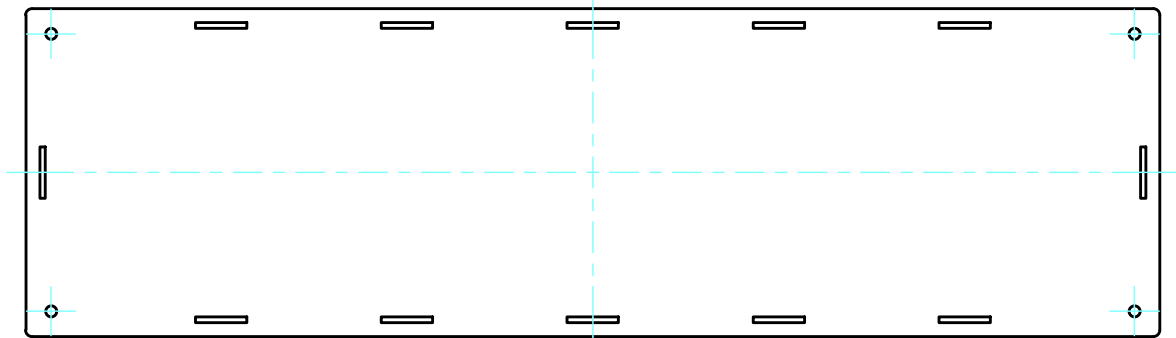
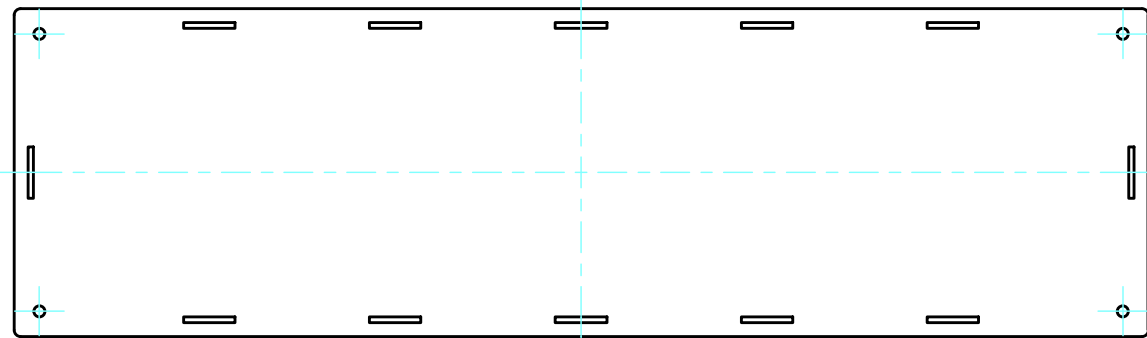

下カバー表面 / Bottom cover Frontside

下カバー裏面 / Bottom cover Backside

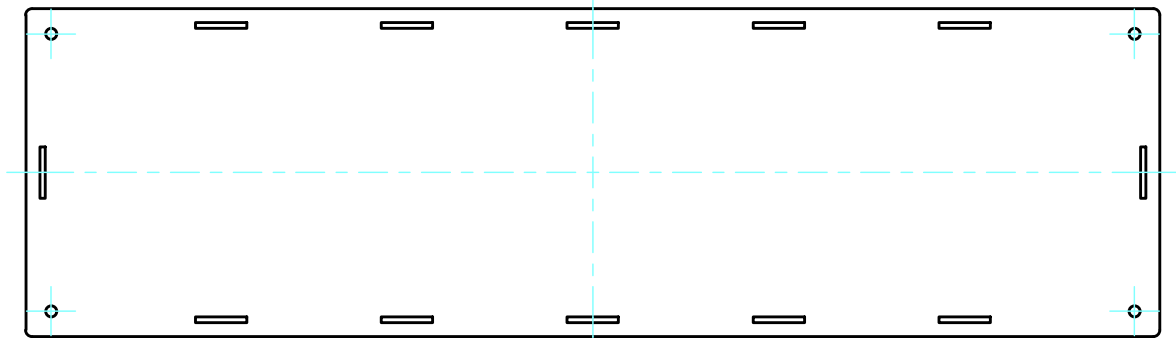
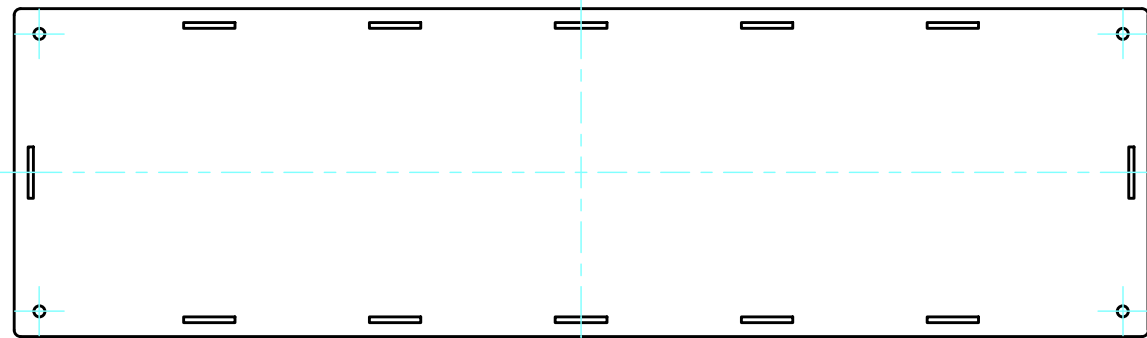

<b>株式会社タカチ電機工業</b> <small>TAKACHI ELECTRONICS ENCLOSURE CO., LTD.</small>			品名/Title コーナーガード付アルミフリーサイズケース CUSTOM SIZED ALUMINIUM FRAME BOX with CORNER GUARD	尺度/Scale 1:3
承認/Approved	検図/Checked	製図/Created	型番/Product number ALGF□-□-□K20□ (W401~500, D101~150)	
中根	中根	常山	作成日/Date 2022/06/24	3 / 6

Wパネル / W Panel

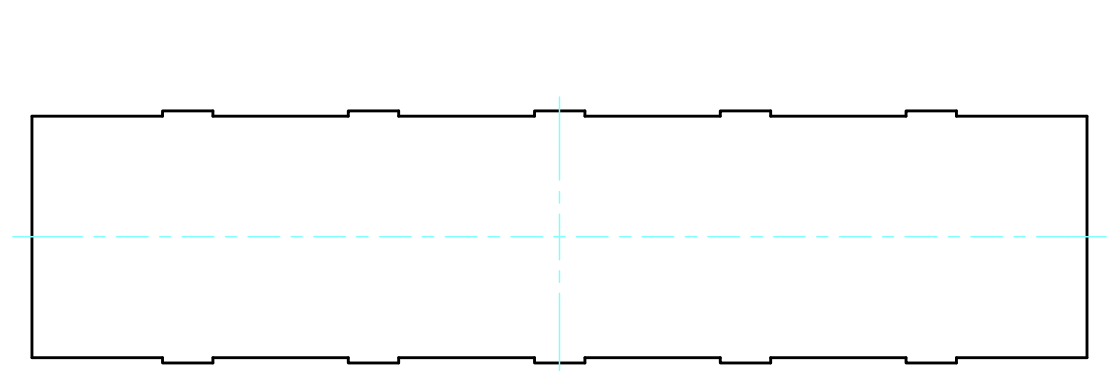
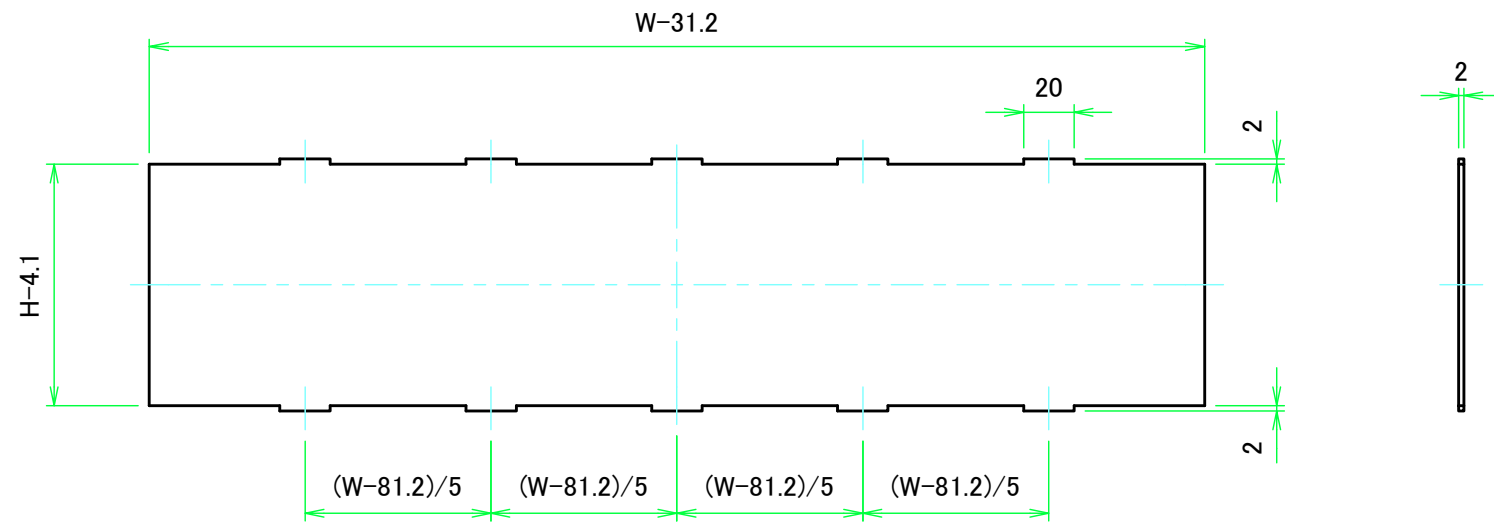

Wパネル1表面 / W Panel 1 Frontside

Wパネル1裏面 / W Panel 1 Backside

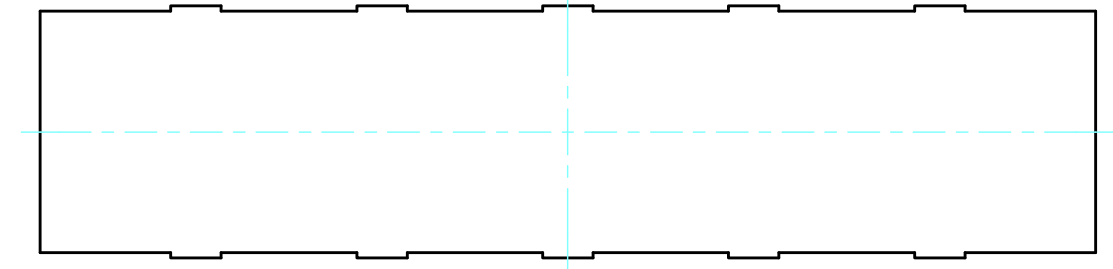
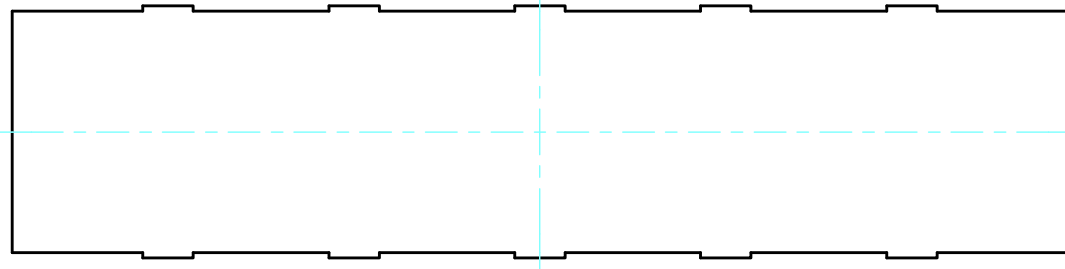

Wパネル2表面 / W Panel 2 Frontside

Wパネル2裏面 / W Panel 2 Backside

 株式会社タカチ電機工業 TAKACHI ELECTRONICS ENCLOSURE CO., LTD.			品名/Title コーナーガード付アルミフリーサイズケース CUSTOM SIZED ALUMINIUM FRAME BOX with CORNER GUARD	 尺度/Scale 1:3
承認/Approved	検図/Checked	製図/Created	型番/Product number ALGF□-□-□K20□ (W401~500, D101~150)	
中根	中根	常山	作成日/Date 2022/06/24	4 / 6

Dパネル / D Panel

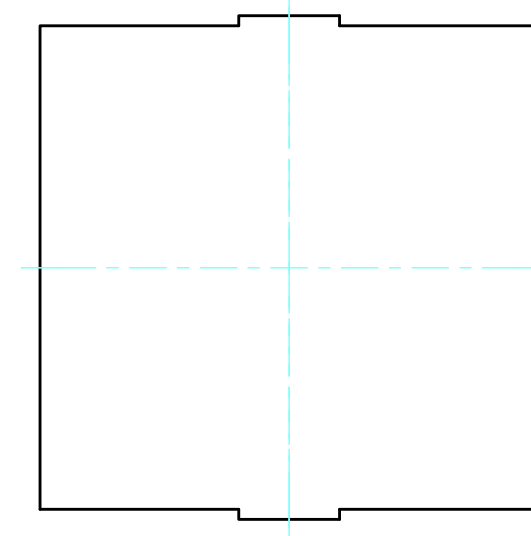
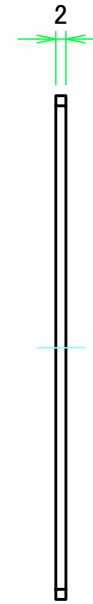
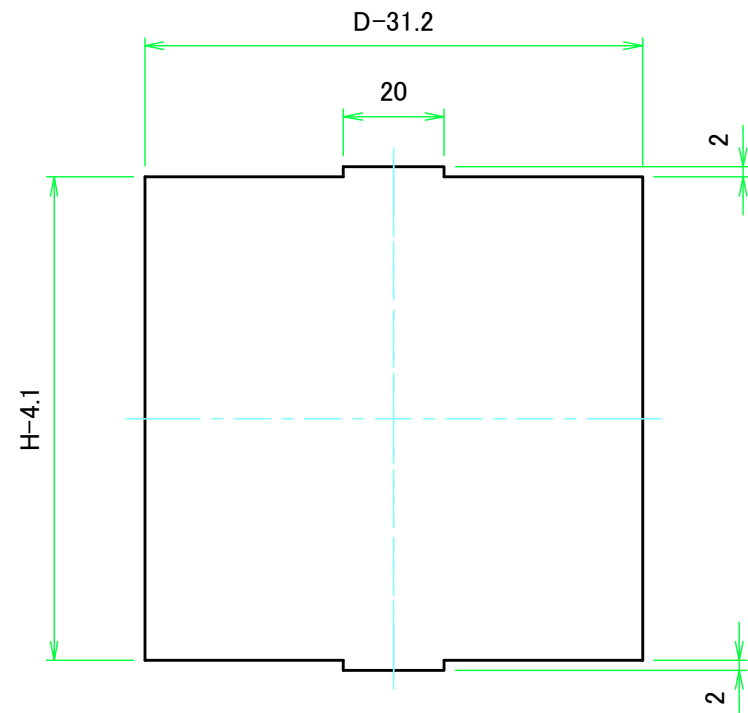

Dパネル1表面 / D Panel 1 Frontside

Dパネル1裏面 / D Panel 1 Backside

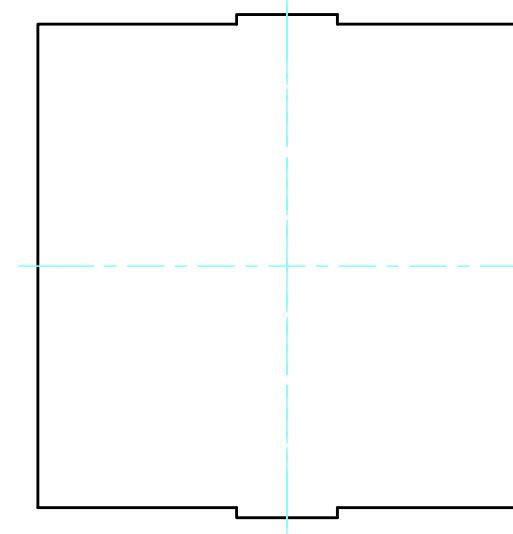
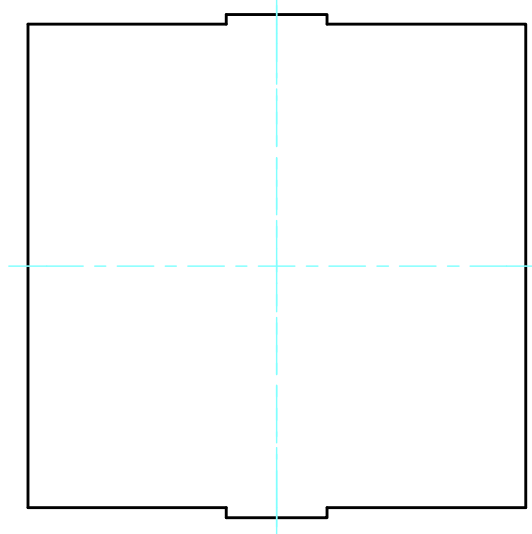

Dパネル2表面 / D Panel 2 Frontside

Dパネル2裏面 / D Panel 2 Backside



株式会社タカチ電機工業 TAKACHI ELECTRONICS ENCLOSURE CO., LTD.			品名/Title コーナーガード付アルミフリーサイズケース CUSTOM SIZED ALUMINIUM FRAME BOX with CORNER GUARD	尺度/Scale 1:1.5
承認/Approved	検図/Checked	製図/Created	型番/Product number ALGF□-□-□K20□ (W401~500, D101~150)	
中根	中根	常山	作成日/Date 2022/06/24	5 / 6

コーナーガード / Corner guard

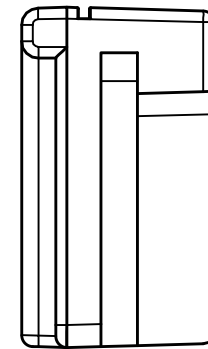
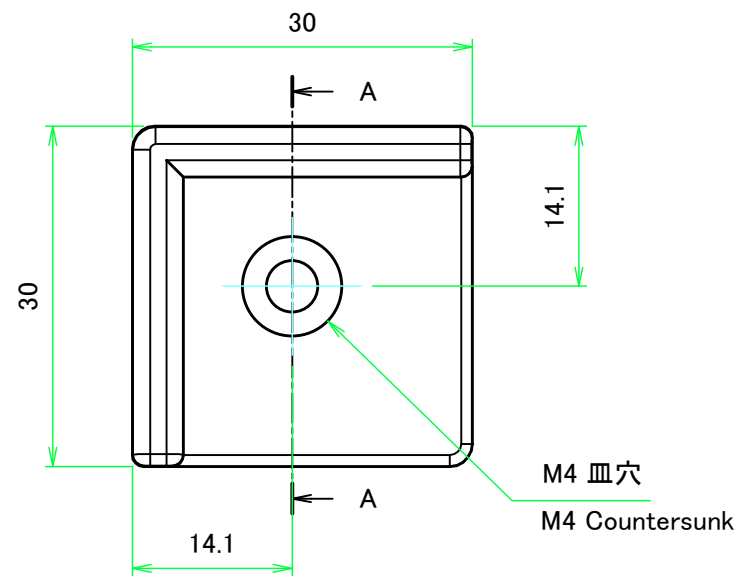
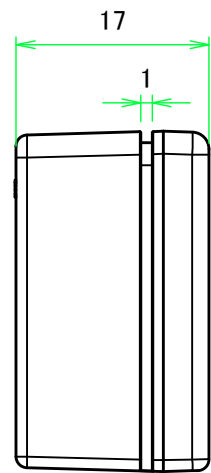
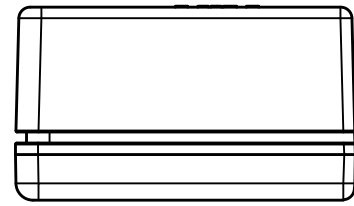

A-A (1.5:1)

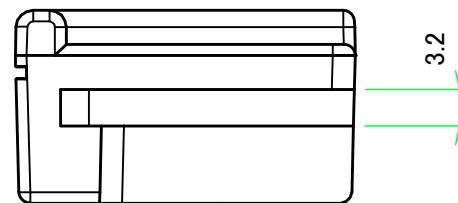
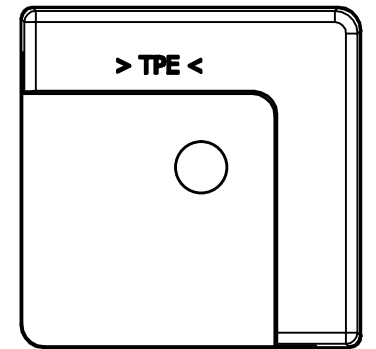
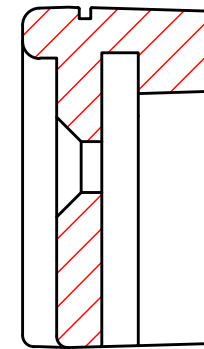

 株式会社タカチ電機工業 TAKACHI ELECTRONICS ENCLOSURE CO., LTD.			品名/Title コーナーガード付アルミフリーサイズケース CUSTOM SIZED ALUMINIUM FRAME BOX with CORNER GUARD	 尺度/Scale 1.5:1
承認/Approved	検図/Checked	製図/Created	型番/Product number ALGF□-□-□K20□ (W401~500, D101~150)	
中根	中根	常山	作成日/Date 2022/06/24	6 / 6